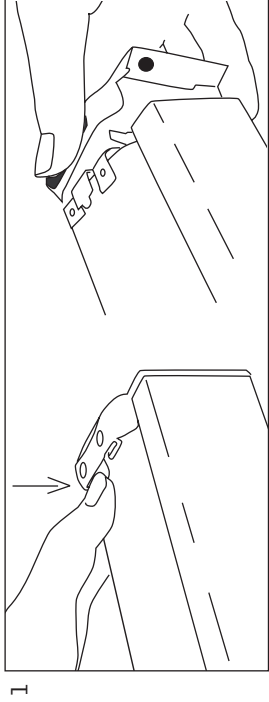
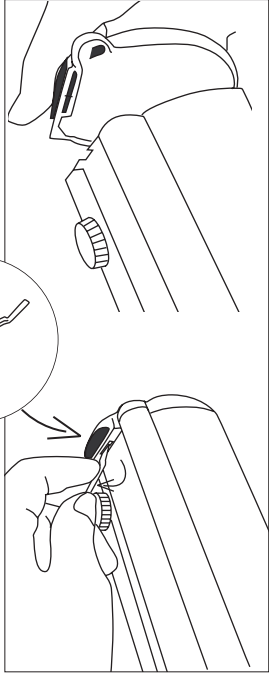

Table mounting

Zap 1



Zap 2



Zap 3

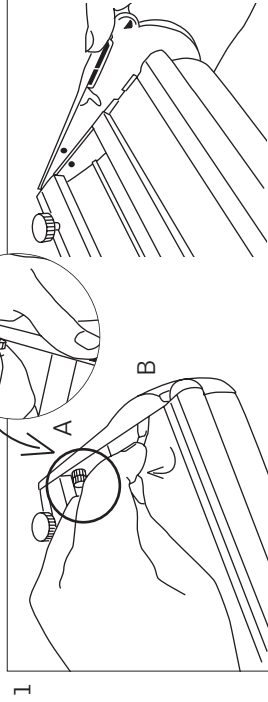

Zap 4

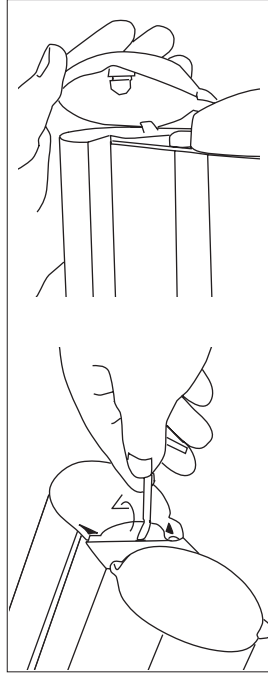

Zap 1, Zap 2, Zap 3, Zap 4

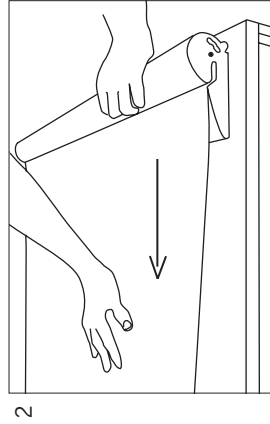

3

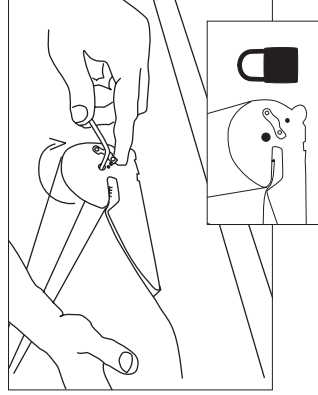

4

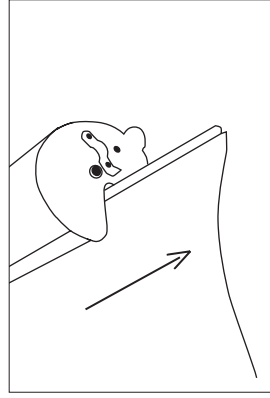

5

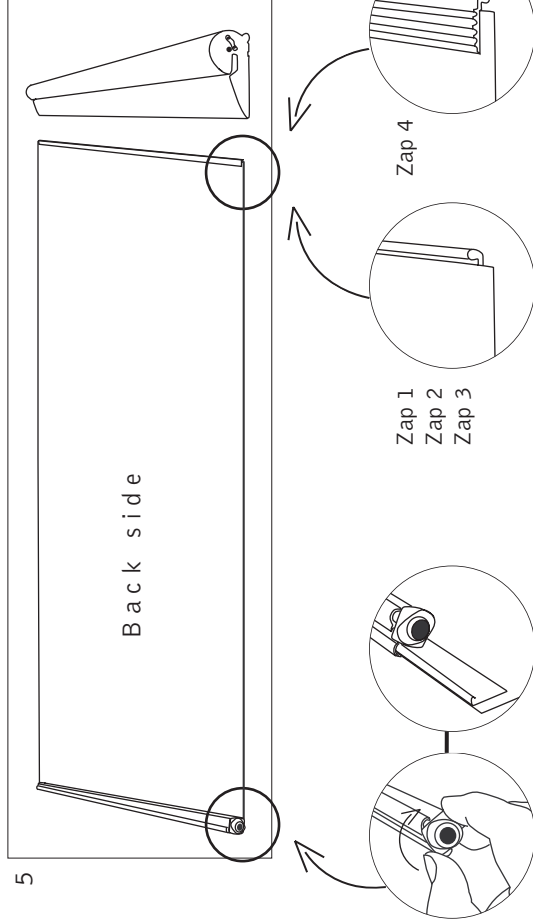

6

